

Mathematics I - Functions

21/22

Limit of a function

Definition

Let $c \in \mathbb{R}$ and $\varepsilon > 0$. We define

- a **neighbourhood of a point** c with radius ε by
 $B(c, \varepsilon) = (c - \varepsilon, c + \varepsilon)$,

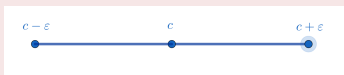

Limit of a function

Definition

Let $c \in \mathbb{R}$ and $\varepsilon > 0$. We define

- a **neighbourhood of a point** c with radius ε by

$$B(c, \varepsilon) = (c - \varepsilon, c + \varepsilon),$$

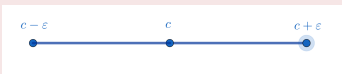

- a **punctured neighbourhood of a point** c with radius ε by

$$P(c, \varepsilon) = (c - \varepsilon, c + \varepsilon) \setminus \{c\}.$$

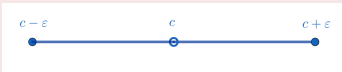

Definition

We say that $A \in \mathbb{R}$ is a **limit of a function f at a point $c \in \mathbb{R}$** if

$$\forall \varepsilon \in \mathbb{R}, \varepsilon > 0 \exists \delta \in \mathbb{R}, \delta > 0 \forall x \in P(c, \delta): f(x) \in B(A, \varepsilon).$$

Definition

We say that $A \in \mathbb{R}$ is a **limit of a function f at a point $c \in \mathbb{R}$** if

$$\forall \varepsilon \in \mathbb{R}, \varepsilon > 0 \exists \delta \in \mathbb{R}, \delta > 0 \forall x \in P(c, \delta): f(x) \in B(A, \varepsilon).$$

Theorem 1 (uniqueness of a limit)

Let f be a function and $c \in \mathbb{R}$. Then f has a most one limit $A \in \mathbb{R}$ at c .

The fact that f has a limit $A \in \mathbb{R}$ at $c \in \mathbb{R}$ is denoted by

$$\lim_{x \rightarrow c} f(x) = A.$$

<https://www.geogebra.org/m/tCnmrWg2>

<https://www.geogebra.org/m/wfdvtRTb>

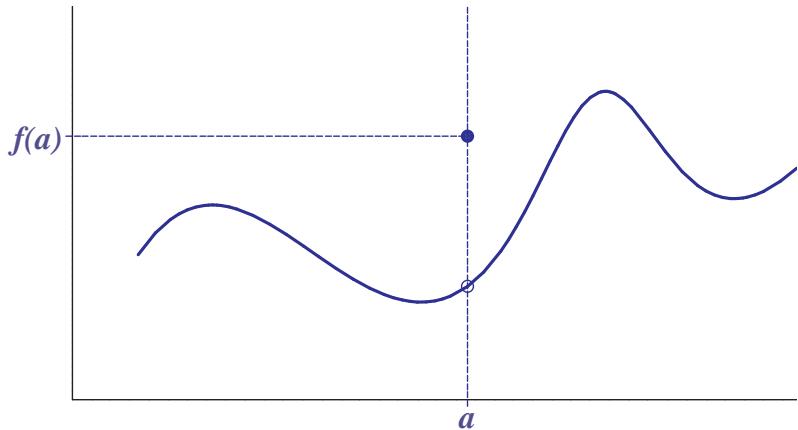

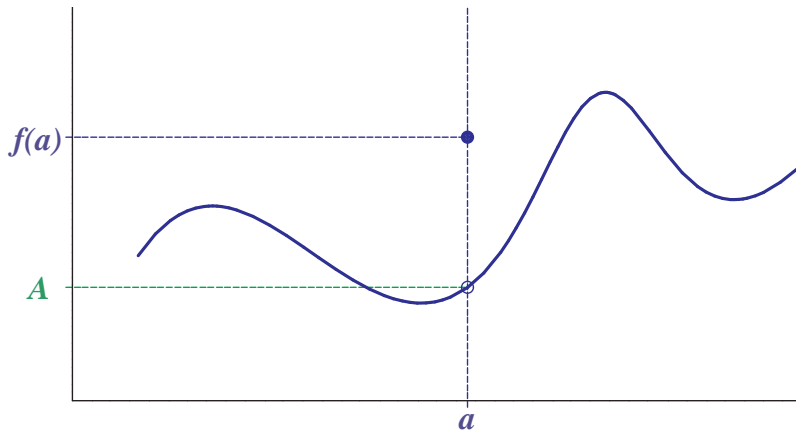

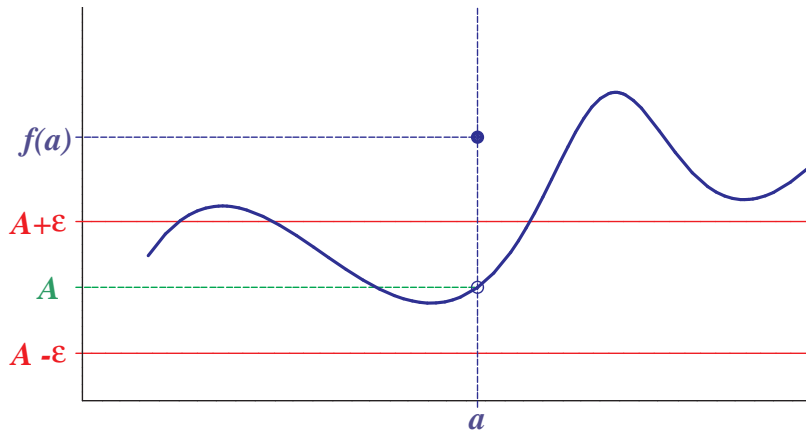

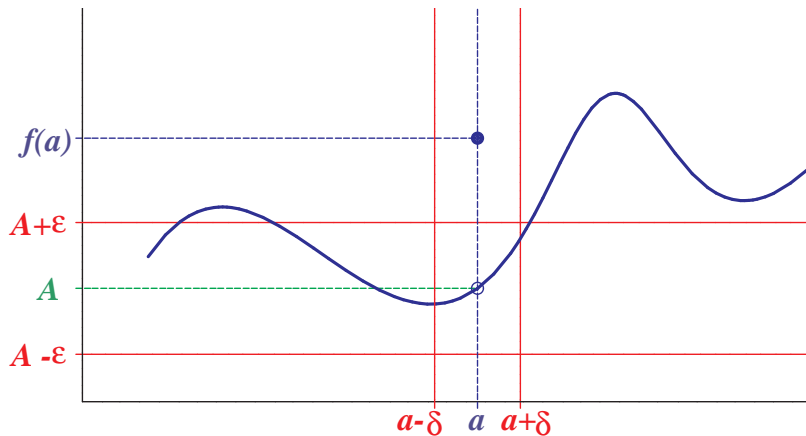

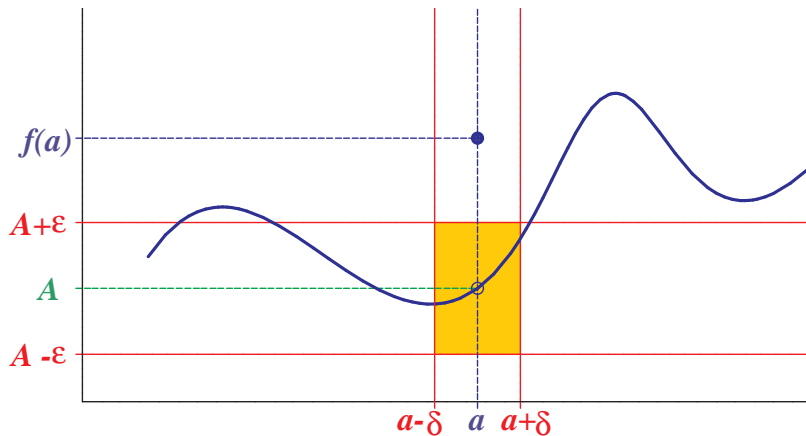

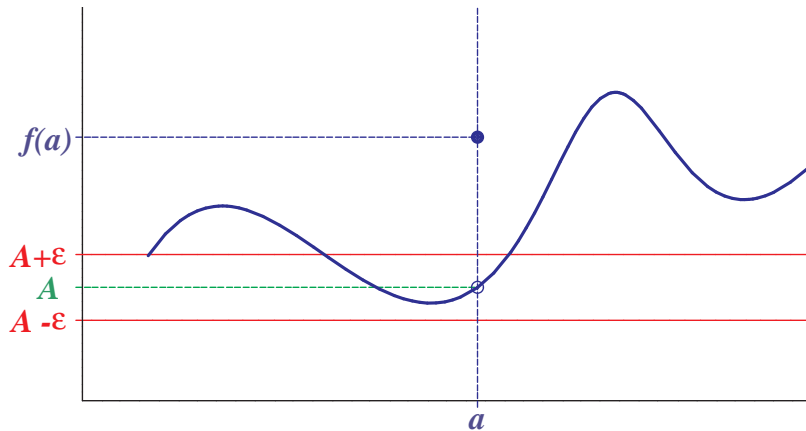

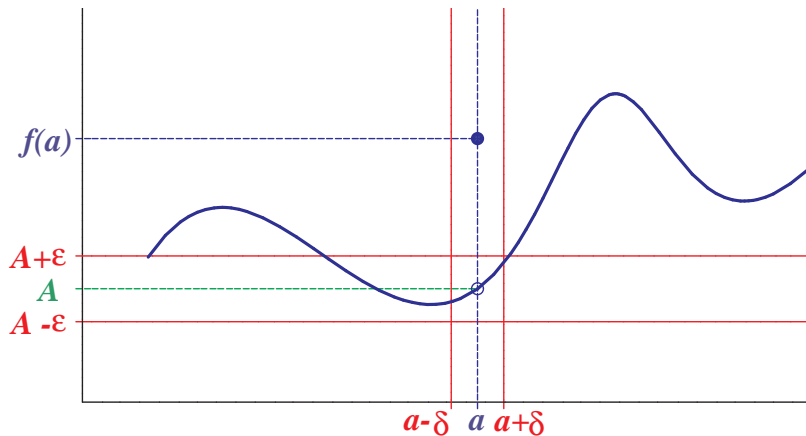

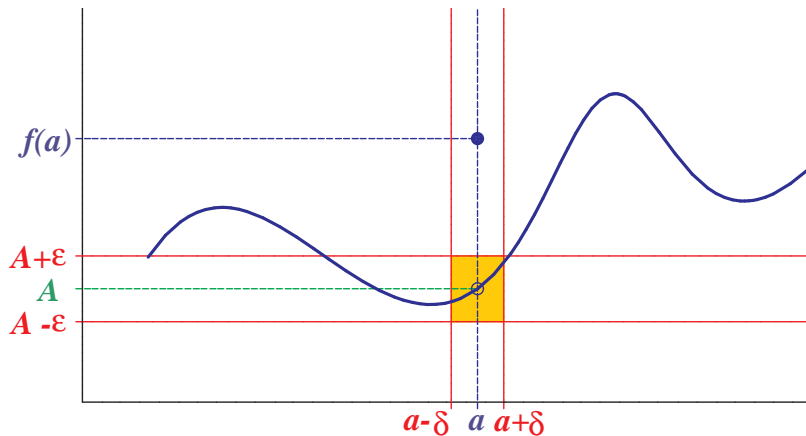

Exercise

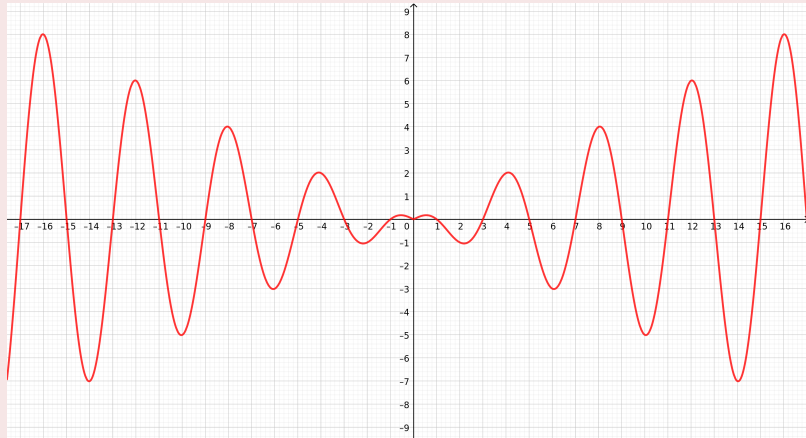

`https://www.geogebra.org/calculator/xjkuxemz`

Exercise

Find $\lim_{x \rightarrow 0} f(x)$

A -3

B 0

C 5

D 7

E ∞

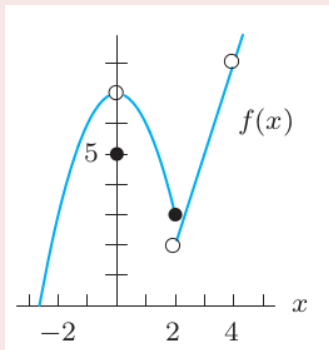

Figure: Calculus: Single and Multivariable, Hughes-Hallett

Exercise

Find $\lim_{x \rightarrow 2} f(x)$

A ∞

B 3

C 2

D 0

E does not exist

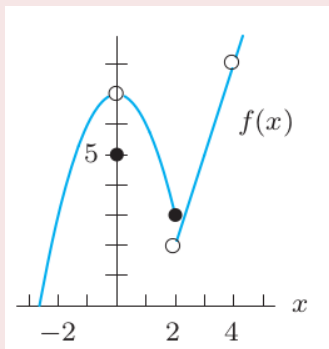

Figure: Calculus: Single and Multivariable, Hughes-Hallett

Exercise

Find $\lim_{x \rightarrow 4} f(x)$

A 4

C 0

E does

exists

B 8

D ∞

not

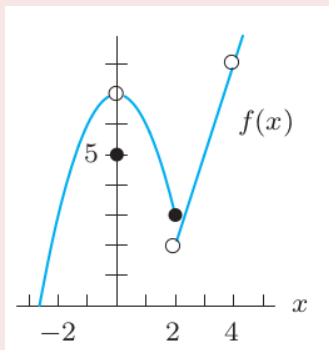

Figure: Calculus: Single and Multivariable, Hughes-Hallett

Definition

Let $\varepsilon > 0$. A neighbourhood and a punctured neighbourhood of $+\infty$ (resp. $-\infty$) is defined as follows:

$$P(+\infty, \varepsilon) = B(+\infty, \varepsilon) = (1/\varepsilon, +\infty),$$

$$P(-\infty, \varepsilon) = B(-\infty, \varepsilon) = (-\infty, -1/\varepsilon).$$

Example

$$P\left(+\infty, \frac{1}{10}\right) = B\left(+\infty, \frac{1}{10}\right) = (10, +\infty),$$

$$P\left(-\infty, \frac{1}{200}\right) = B\left(-\infty, \frac{1}{200}\right) = (-\infty, -200).$$

Definition

Let $\varepsilon > 0$. A neighbourhood and a punctured neighbourhood of $+\infty$ (resp. $-\infty$) is defined as follows:

$$P(+\infty, \varepsilon) = B(+\infty, \varepsilon) = (1/\varepsilon, +\infty),$$

$$P(-\infty, \varepsilon) = B(-\infty, \varepsilon) = (-\infty, -1/\varepsilon).$$

Definition

We say that $A \in \mathbb{R}^*$ is a **limit of a function f** at $c \in \mathbb{R}^*$ if

$$\forall \varepsilon \in \mathbb{R}, \varepsilon > 0 \exists \delta \in \mathbb{R}, \delta > 0 \forall x \in P(c, \delta): f(x) \in B(A, \varepsilon).$$

Definition

Let $\varepsilon > 0$. A neighbourhood and a punctured neighbourhood of $+\infty$ (resp. $-\infty$) is defined as follows:

$$P(+\infty, \varepsilon) = B(+\infty, \varepsilon) = (1/\varepsilon, +\infty),$$

$$P(-\infty, \varepsilon) = B(-\infty, \varepsilon) = (-\infty, -1/\varepsilon).$$

Definition

We say that $A \in \mathbb{R}^*$ is a **limit of a function f at $c \in \mathbb{R}^*$** if

$$\forall \varepsilon \in \mathbb{R}, \varepsilon > 0 \exists \delta \in \mathbb{R}, \delta > 0 \forall x \in P(c, \delta): f(x) \in B(A, \varepsilon).$$

Theorem 1 holds also for $c \in \mathbb{R}^*$, $A \in \mathbb{R}^*$, so we can again use the notation $\lim_{x \rightarrow c} f(x) = A$.

Exercise

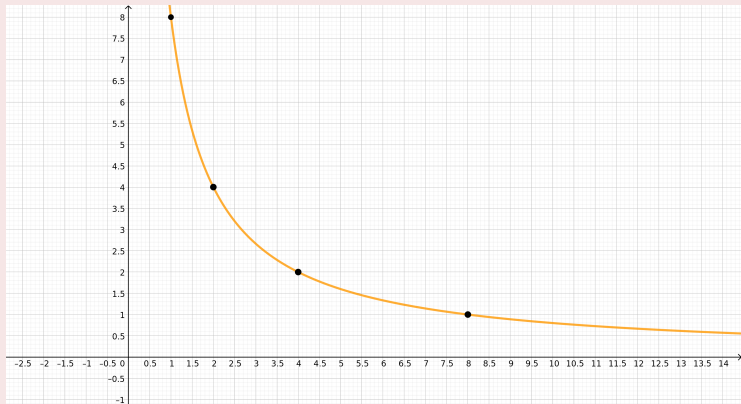

`https://www.geogebra.org/calculator/xjkuxemz`

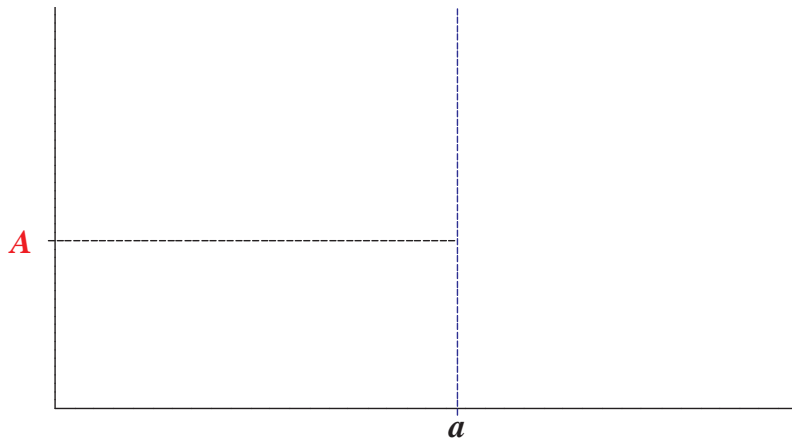

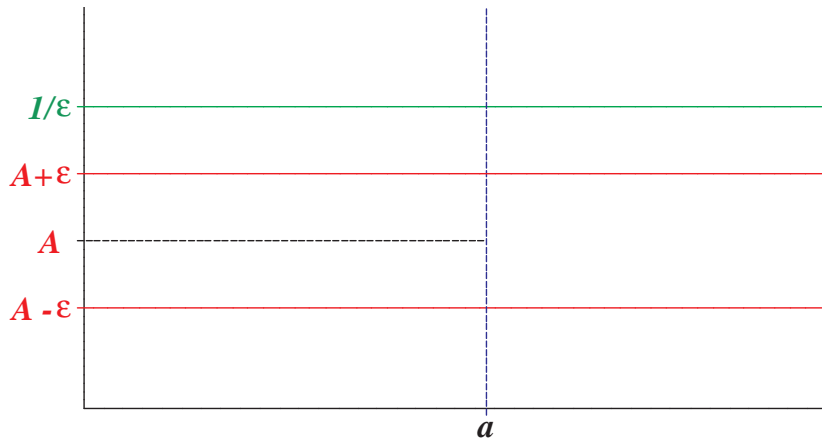

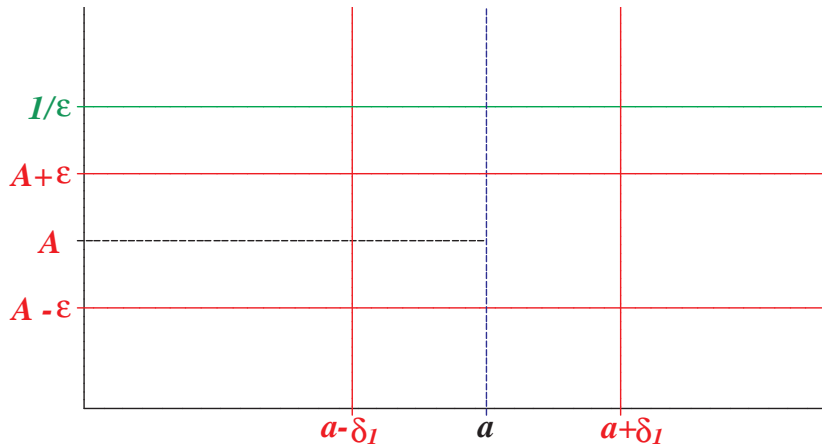

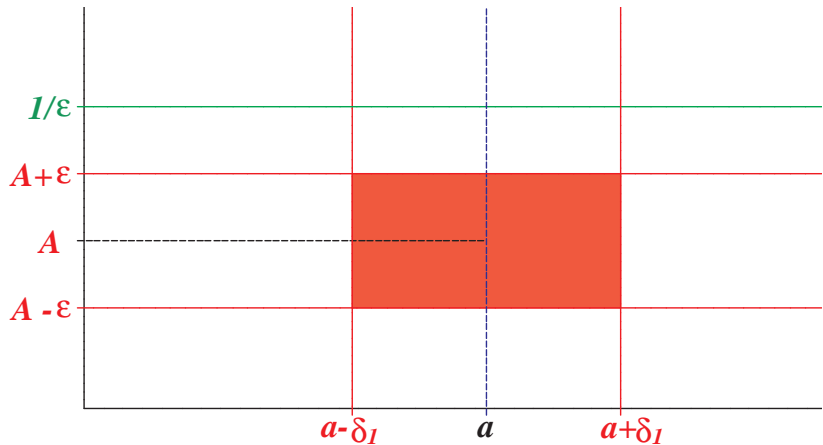

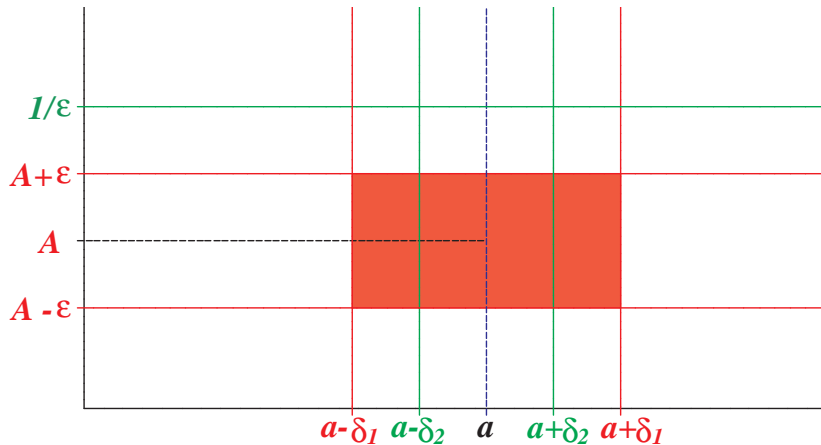

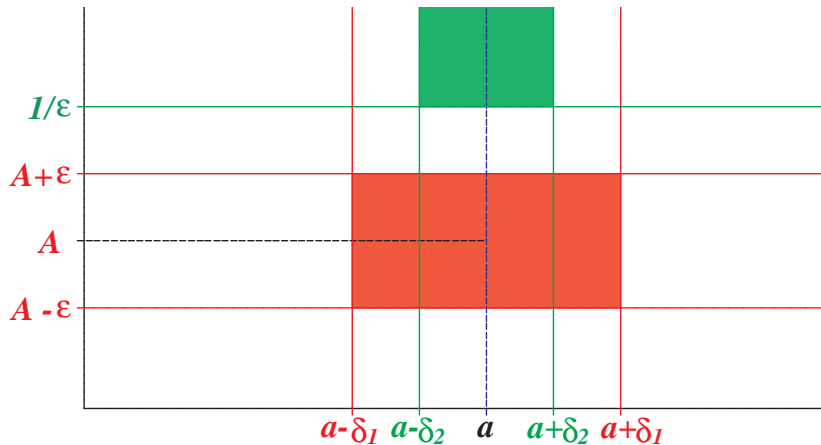

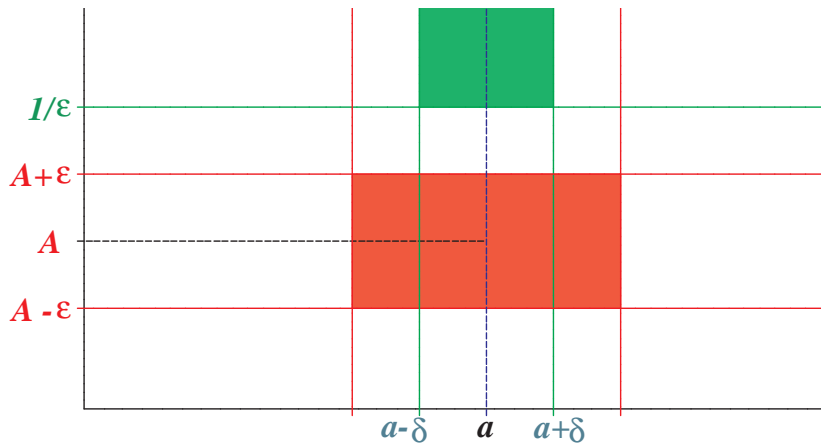

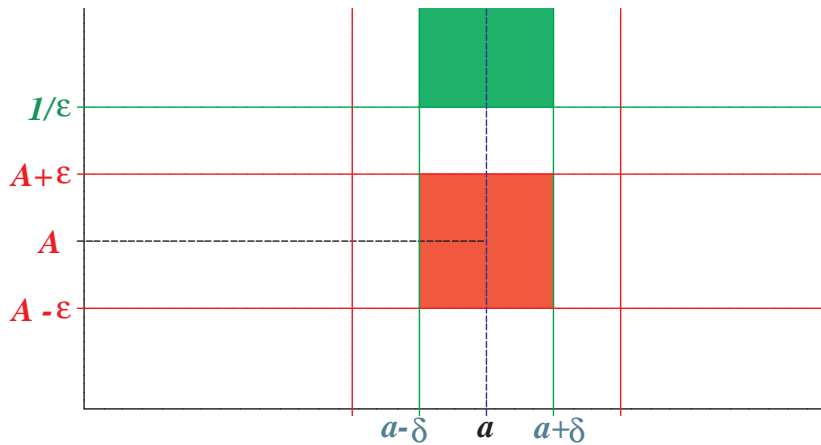



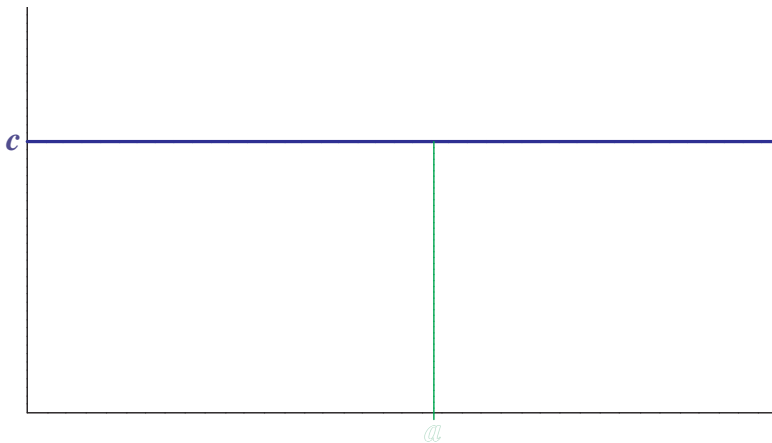

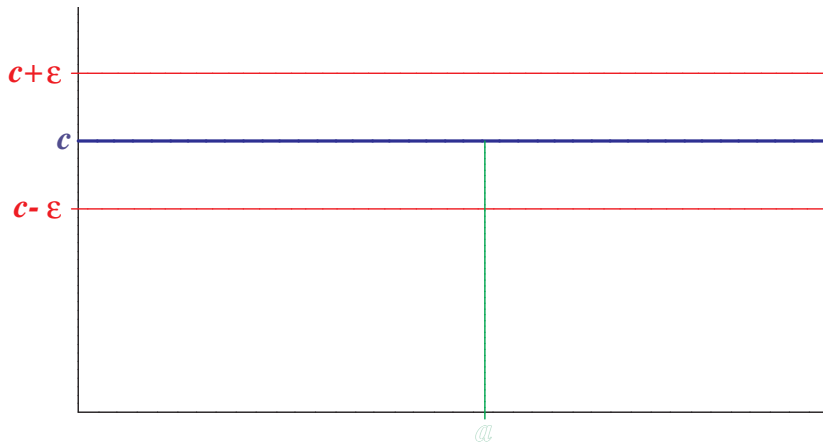

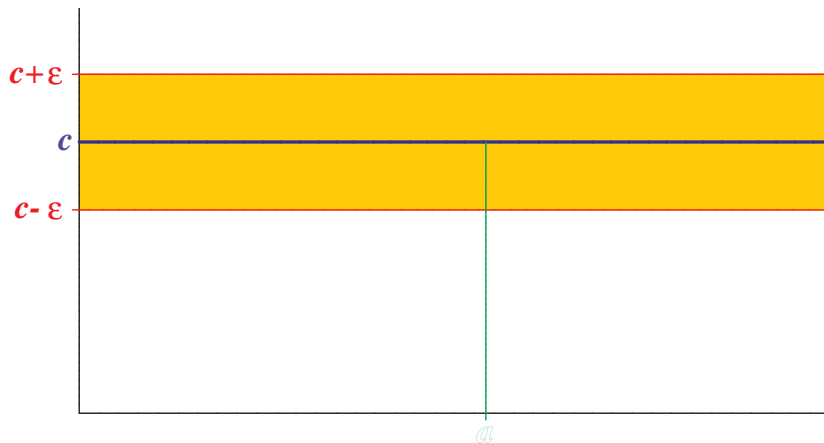

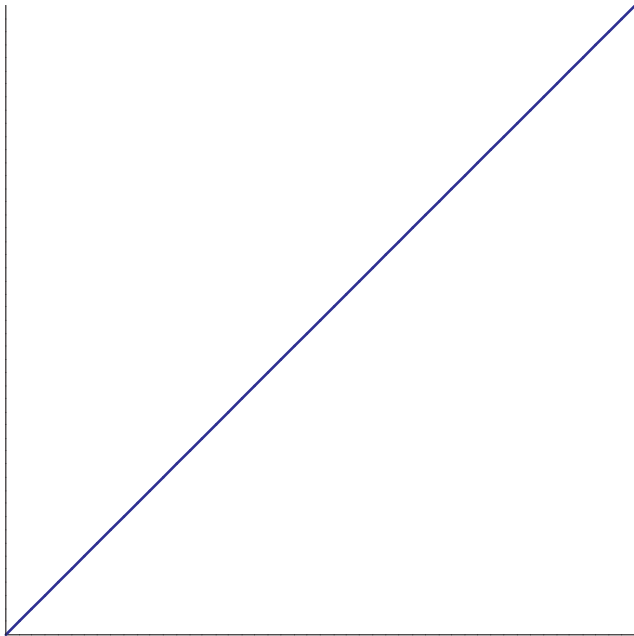

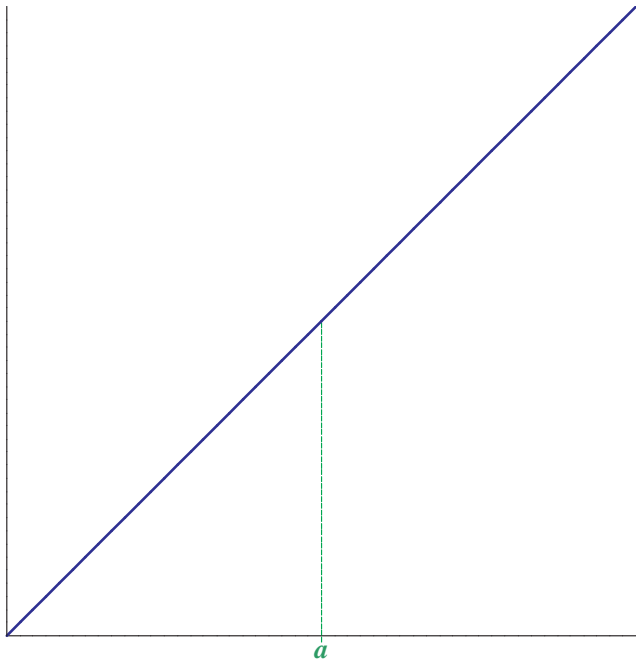

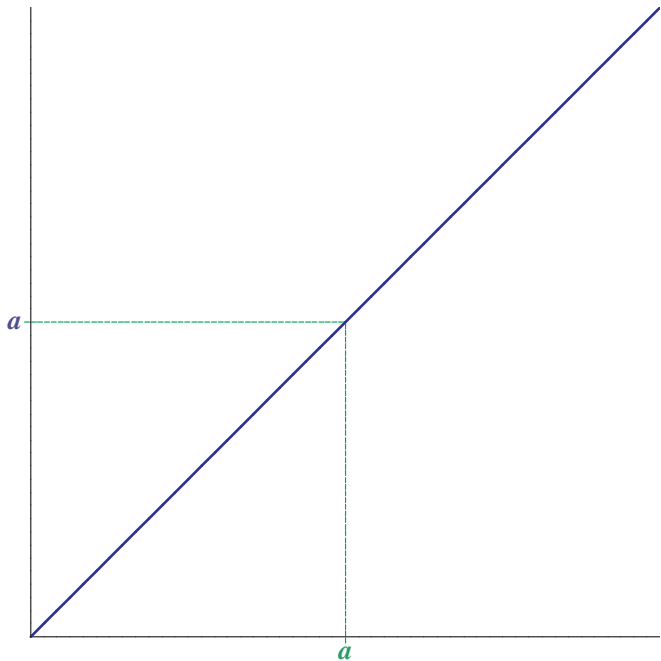

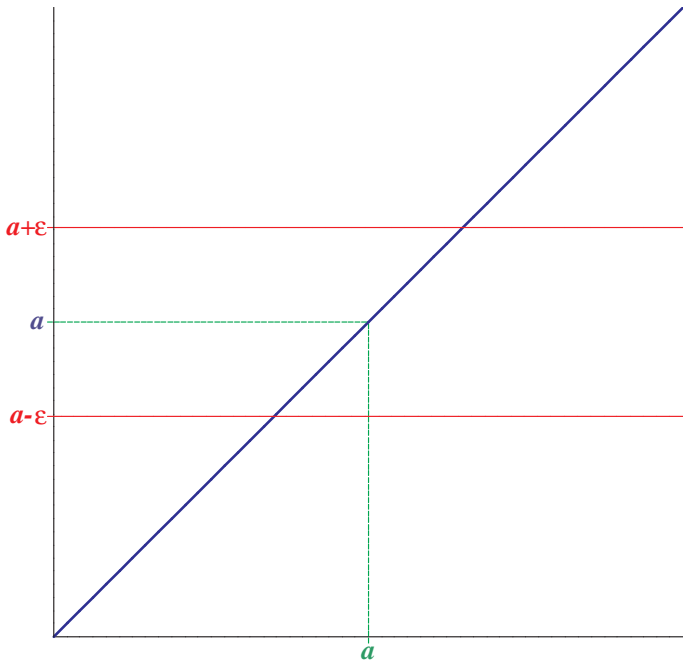

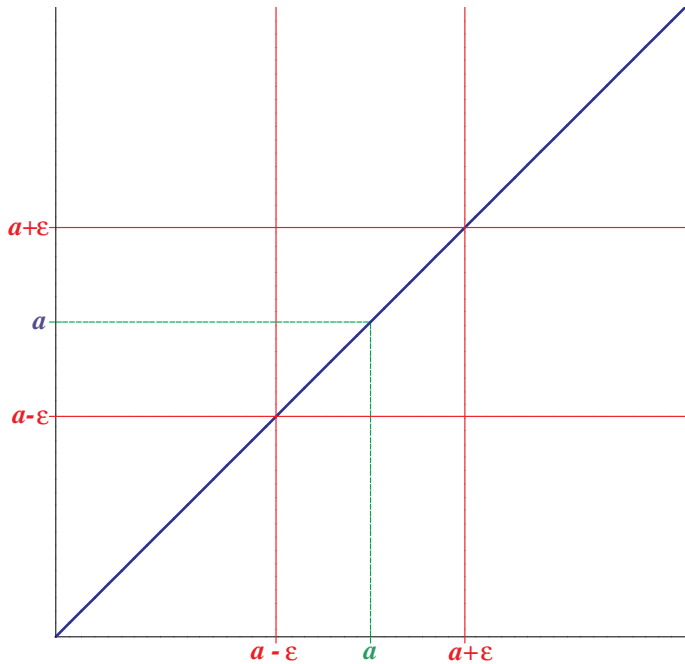

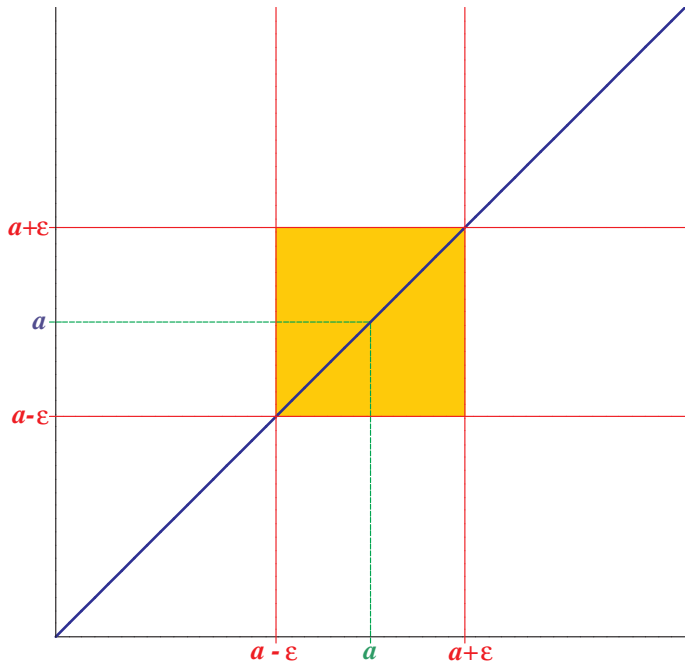

Definition

Let $c \in \mathbb{R}$ and $\varepsilon > 0$. We define

- a **right neighbourhood** of c by $B^+(c, \varepsilon) = [c, c + \varepsilon)$,

Definition

Let $c \in \mathbb{R}$ and $\varepsilon > 0$. We define

- a **right neighbourhood** of c by $B^+(c, \varepsilon) = [c, c + \varepsilon)$,
- a **left neighbourhood** of c by $B^-(c, \varepsilon) = (c - \varepsilon, c]$,

Definition

Let $c \in \mathbb{R}$ and $\varepsilon > 0$. We define

- a **right neighbourhood** of c by $B^+(c, \varepsilon) = [c, c + \varepsilon)$,
- a **left neighbourhood** of c by $B^-(c, \varepsilon) = (c - \varepsilon, c]$,
- a **right punctured neighbourhood** of c by $P^+(c, \varepsilon) = (c, c + \varepsilon)$,

Definition

Let $c \in \mathbb{R}$ and $\varepsilon > 0$. We define

- a **right neighbourhood** of c by $B^+(c, \varepsilon) = [c, c + \varepsilon)$,
- a **left neighbourhood** of c by $B^-(c, \varepsilon) = (c - \varepsilon, c]$,
- a **right punctured neighbourhood** of c by $P^+(c, \varepsilon) = (c, c + \varepsilon)$,
- a **left punctured neighbourhood** of c by $P^-(c, \varepsilon) = (c - \varepsilon, c)$,

Definition

Let $c \in \mathbb{R}$ and $\varepsilon > 0$. We define

- a **right neighbourhood** of c by $B^+(c, \varepsilon) = [c, c + \varepsilon)$,
- a **left neighbourhood** of c by $B^-(c, \varepsilon) = (c - \varepsilon, c]$,
- a **right punctured neighbourhood** of c by $P^+(c, \varepsilon) = (c, c + \varepsilon)$,
- a **left punctured neighbourhood** of c by $P^-(c, \varepsilon) = (c - \varepsilon, c)$,
- a **left neighbourhood and left punctured neighbourhood** of $+\infty$ by $B^-(+\infty, \varepsilon) = P^-(+\infty, \varepsilon) = (1/\varepsilon, +\infty)$,

Definition

Let $c \in \mathbb{R}$ and $\varepsilon > 0$. We define

- a **right neighbourhood** of c by $B^+(c, \varepsilon) = [c, c + \varepsilon)$,
- a **left neighbourhood** of c by $B^-(c, \varepsilon) = (c - \varepsilon, c]$,
- a **right punctured neighbourhood** of c by $P^+(c, \varepsilon) = (c, c + \varepsilon)$,
- a **left punctured neighbourhood** of c by $P^-(c, \varepsilon) = (c - \varepsilon, c)$,
- a **left neighbourhood and left punctured neighbourhood** of $+\infty$ by $B^-(+\infty, \varepsilon) = P^-(+\infty, \varepsilon) = (1/\varepsilon, +\infty)$,
- a **right neighbourhood and right punctured neighbourhood** of $-\infty$ by $B^+(-\infty, \varepsilon) = P^+(-\infty, \varepsilon) = (-\infty, -1/\varepsilon)$.

Definition

Let $A \in \mathbb{R}^*$, $c \in \mathbb{R} \cup \{-\infty\}$. We say that a function f has a **limit from the right** at c equal to $A \in \mathbb{R}^*$ (denoted by

$\lim_{x \rightarrow c^+} f(x) = A$) if

$$\forall \varepsilon \in \mathbb{R}, \varepsilon > 0 \exists \delta \in \mathbb{R}, \delta > 0 \forall x \in P^+(c, \delta): f(x) \in B(A, \varepsilon).$$

Analogously we define the notion of **limit from the left** at $c \in \mathbb{R} \cup \{+\infty\}$ and we use the notation $\lim_{x \rightarrow c^-} f(x)$.

Definition

Let $A \in \mathbb{R}^*$, $c \in \mathbb{R} \cup \{-\infty\}$. We say that a function f has a **limit from the right** at c equal to $A \in \mathbb{R}^*$ (denoted by

$$\lim_{x \rightarrow c^+} f(x) = A) \text{ if}$$

$$\forall \varepsilon \in \mathbb{R}, \varepsilon > 0 \exists \delta \in \mathbb{R}, \delta > 0 \forall x \in P^+(c, \delta) : f(x) \in B(A, \varepsilon).$$

Analogously we define the notion of **limit from the left** at $c \in \mathbb{R} \cup \{+\infty\}$ and we use the notation $\lim_{x \rightarrow c^-} f(x)$.

Remark

Let $c \in \mathbb{R}$, $A \in \mathbb{R}^*$. Then

$$\lim_{x \rightarrow c} f(x) = A \Leftrightarrow \left(\lim_{x \rightarrow c^+} f(x) = A \ \& \ \lim_{x \rightarrow c^-} f(x) = A \right).$$

Exercise

Find $\lim_{x \rightarrow 2^-} f(x)$.

Find $\lim_{x \rightarrow 2^+} f(x)$.

A 0

B 1

C 2

D 3

E does not exist

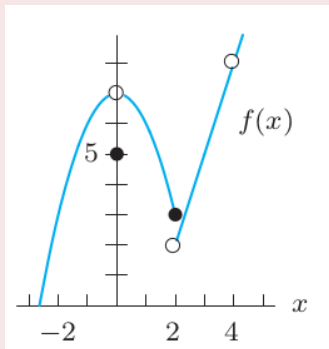
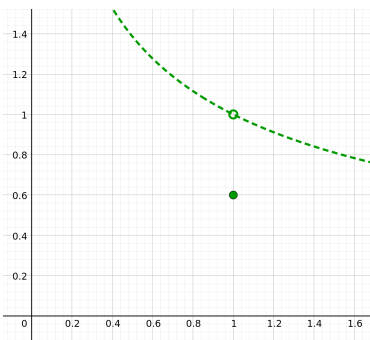
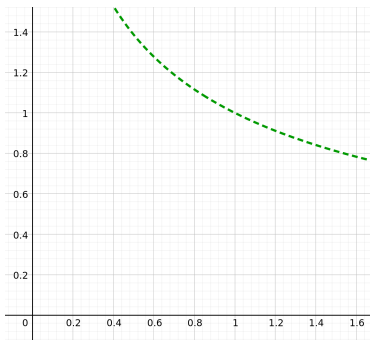

Figure: Calculus: Single and Multivariable, Hughes-Hallett

Definition

We say that a function f is **continuous at a point** $c \in \mathbb{R}$ if

$$\lim_{x \rightarrow c} f(x) = f(c).$$



Definition

Let $c \in \mathbb{R}$. We say that a function f is **continuous at c from the right** (**from the left**, resp.) if $\lim_{x \rightarrow c^+} f(x) = f(c)$ ($\lim_{x \rightarrow c^-} f(x) = f(c)$, resp.).

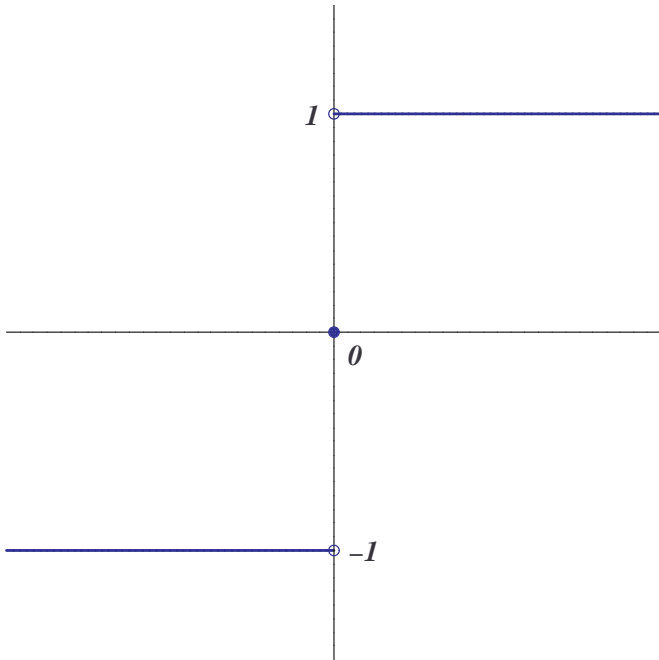

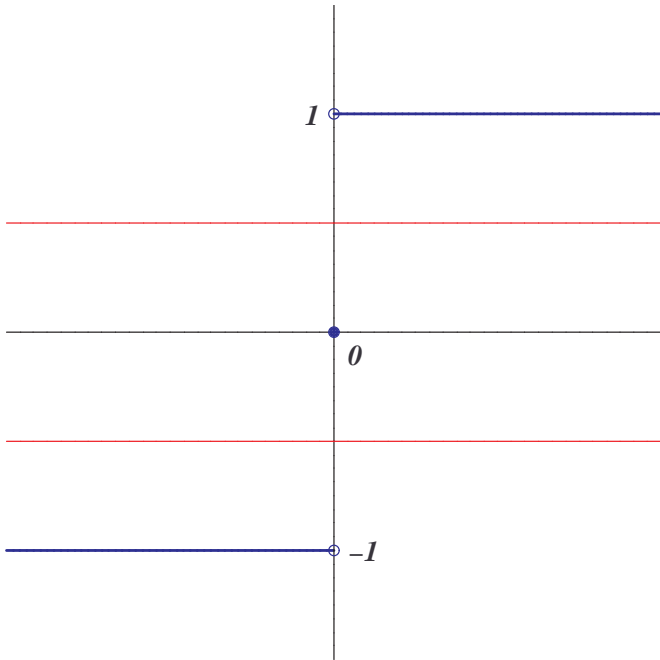

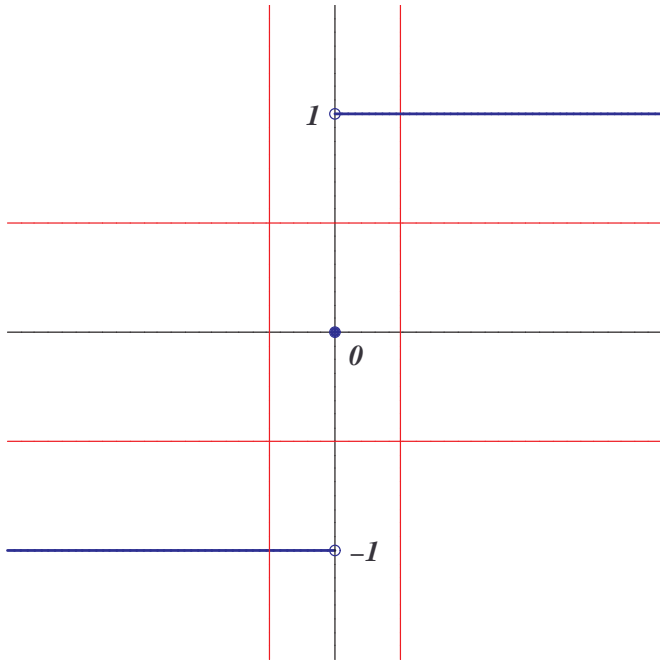

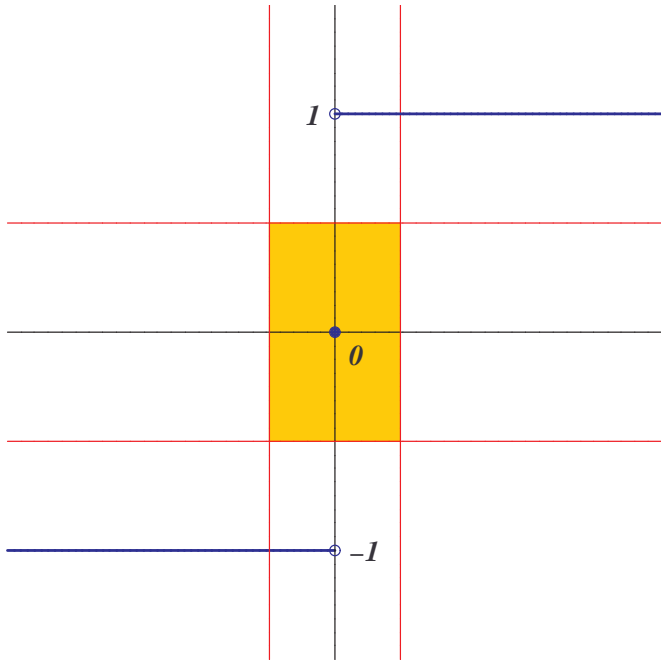

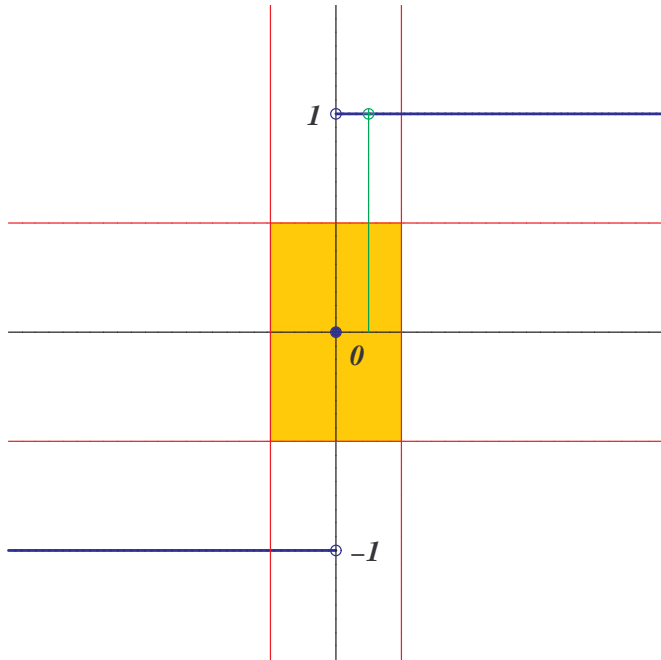

Theorem 2

Let f has a finite limit at $c \in \mathbb{R}^$. Then there exists $\delta > 0$ such that f is bounded on $P(c, \delta)$.*

Theorem 3 (arithmetics of limits)

Let $c \in \mathbb{R}^*$, $\lim_{x \rightarrow c} f(x) = A \in \mathbb{R}^*$ and $\lim_{x \rightarrow c} g(x) = B \in \mathbb{R}^*$.

Then

- (i) $\lim_{x \rightarrow c} (f(x) + g(x)) = A + B$ if the expression $A + B$ is defined,
- (ii) $\lim_{x \rightarrow c} f(x)g(x) = AB$ if the expression AB is defined,
- (iii) $\lim_{x \rightarrow c} f(x)/g(x) = A/B$ if the expression A/B is defined.

Exercise

Find $\lim_{x \rightarrow 1^+} f(x) + 2g(x)$

A 13

C 8

E 3

B 9

D 6

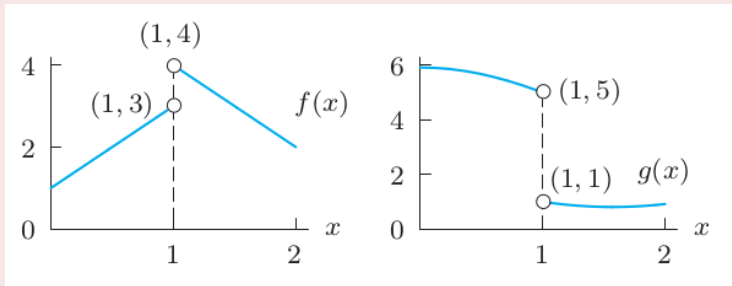

Figure: Calculus: Single and Multivariable, Hughes-Hallett

Exercise

Find $\lim_{x \rightarrow 1^-} f(x)g(x)$

A 20

C 4

E does not exist

B 15

D 3

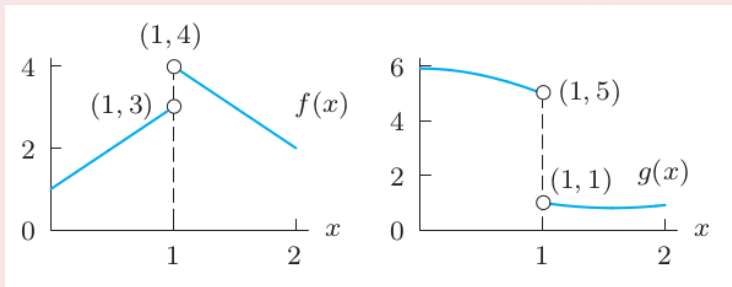

Figure: Calculus: Single and Multivariable, Hughes-Hallett

Corollary

Suppose that the functions f and g are continuous at $c \in \mathbb{R}$. Then also the functions $f + g$ and fg are continuous at c . If moreover $g(c) \neq 0$, then also the function f/g is continuous at c .

Corollary

Suppose that the functions f and g are continuous at $c \in \mathbb{R}$. Then also the functions $f + g$ and fg are continuous at c . If moreover $g(c) \neq 0$, then also the function f/g is continuous at c .

Exercise

Which functions are continuous at \mathbb{R} ?

A $x^3 + \sin(4 - x)$

C $\frac{2+x}{e^x}$

E $\ln(2 + x^2)$

B $\frac{e^x}{2+x}$

D $\cos(e^{\sqrt[3]{x}})$

Theorem 4

Let $c \in \mathbb{R}^*$, $\lim_{x \rightarrow c} g(x) = 0$, $\lim_{x \rightarrow c} f(x) = A \in \mathbb{R}^*$ and $A > 0$.
If there exists $\eta > 0$ such that the function g is positive on $P(c, \eta)$, then $\lim_{x \rightarrow c} (f(x)/g(x)) = +\infty$.

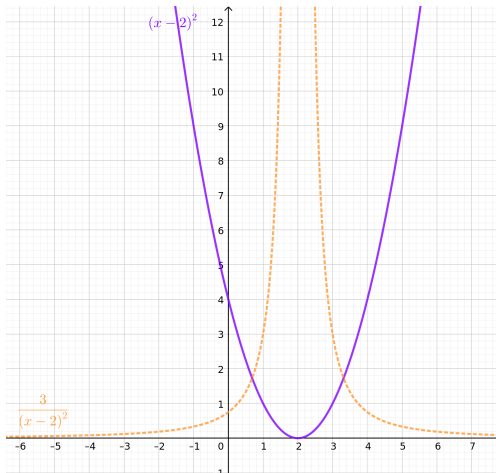

Theorem 5 (limits and inequalities)

Suppose that $c \in \mathbb{R}^*$ and $\lim_{x \rightarrow c} f(x)$, $\lim_{x \rightarrow c} g(x)$ exist.

(i) If $\lim_{x \rightarrow c} f(x) > \lim_{x \rightarrow c} g(x)$, then there exists $\delta > 0$ such that

$$\forall x \in P(c, \delta) : f(x) > g(x).$$

Theorem 5 (limits and inequalities)

Suppose that $c \in \mathbb{R}^*$ and $\lim_{x \rightarrow c} f(x)$, $\lim_{x \rightarrow c} g(x)$ exist.

(i) If $\lim_{x \rightarrow c} f(x) > \lim_{x \rightarrow c} g(x)$, then there exists $\delta > 0$ such that

$$\forall x \in P(c, \delta): f(x) > g(x).$$

(ii) If there exists $\delta > 0$ such that $\forall x \in P(c, \delta): f(x) \leq g(x)$, then

$$\lim_{x \rightarrow c} f(x) \leq \lim_{x \rightarrow c} g(x).$$

Theorem 5 (limits and inequalities)

Suppose that $c \in \mathbb{R}^*$ and $\lim_{x \rightarrow c} f(x)$, $\lim_{x \rightarrow c} g(x)$ exist.

(i) If $\lim_{x \rightarrow c} f(x) > \lim_{x \rightarrow c} g(x)$, then there exists $\delta > 0$ such that

$$\forall x \in P(c, \delta): f(x) > g(x).$$

(ii) If there exists $\delta > 0$ such that $\forall x \in P(c, \delta): f(x) \leq g(x)$, then

$$\lim_{x \rightarrow c} f(x) \leq \lim_{x \rightarrow c} g(x).$$

(iii) (two policemen/sandwich theorem) Suppose that there exists $\eta > 0$ such that

$$\forall x \in P(c, \eta): f(x) \leq h(x) \leq g(x).$$

If moreover $\lim_{x \rightarrow c} f(x) = \lim_{x \rightarrow c} g(x) = A \in \mathbb{R}^*$, then the limit $\lim_{x \rightarrow c} h(x)$ also exists and equals A .

$$\frac{x^2}{3} \cos(8x + 3)$$

$$\frac{\sin(4x)}{x}$$

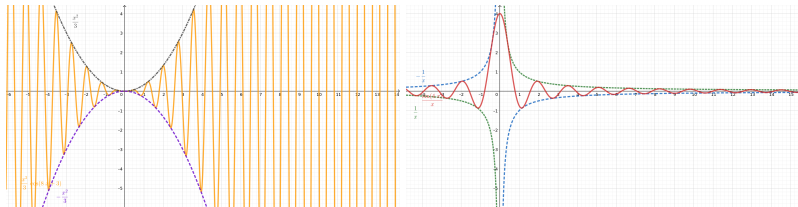

https:
[//www.geogebra.org/calculator/dvqdpqag](https://www.geogebra.org/calculator/dvqdpqag)

Corollary

Let $c \in \mathbb{R}^*$, $\lim_{x \rightarrow c} f(x) = 0$ and suppose there exists $\eta > 0$ such that g is bounded on $P(c, \eta)$. Then $\lim_{x \rightarrow c} (f(x)g(x)) = 0$.

Example

$$\lim_{x \rightarrow 0} (\sin x)(\operatorname{sgn} x)$$

Theorem 6 (limit of a composition)

Let $c, A, B \in \mathbb{R}^*$, $\lim_{x \rightarrow c} g(x) = A$, $\lim_{y \rightarrow A} f(y) = B$ and at least one of the following conditions is satisfied:

- (I) $\exists \eta \in \mathbb{R}, \eta > 0 \forall x \in P(c, \eta): g(x) \neq A$,
- (C) the function f is continuous at A .

Then

$$\lim_{x \rightarrow c} f(g(x)) = B.$$

Theorem 6 (limit of a composition)

Let $c, A, B \in \mathbb{R}^*$, $\lim_{x \rightarrow c} g(x) = A$, $\lim_{y \rightarrow A} f(y) = B$ and at least one of the following conditions is satisfied:

- (I) $\exists \eta \in \mathbb{R}, \eta > 0 \forall x \in P(c, \eta): g(x) \neq A$,
- (C) the function f is continuous at A .

Then

$$\lim_{x \rightarrow c} f(g(x)) = B.$$

Corollary

Suppose that the function g is continuous at $c \in \mathbb{R}$ and the function f is continuous at $g(c)$. Then the function $f \circ g$ is continuous at c .

Exercise

$$\lim_{x \rightarrow \infty} \ln \left(\frac{x-1}{x+2} \right)$$

A 0

B 1

C $\ln 1$

D $-\frac{1}{2}$

E ∞

Exercise

$$\lim_{x \rightarrow \infty} \ln \left(\frac{x-1}{x+2} \right)$$

A 0

B 1

C $\ln 1$

D $-\frac{1}{2}$

E ∞

Exercise

$$\lim_{x \rightarrow -\infty} \cos \frac{1}{x}$$

A 0

B 1

C π

D $-\infty$

E does not exist

Exercise

$$\lim_{x \rightarrow \infty} \ln \left(\frac{x-1}{x+2} \right)$$

A 0

B 1

C $\ln 1$

D $-\frac{1}{2}$

E ∞

Exercise

$$\lim_{x \rightarrow -\infty} \cos \frac{1}{x}$$

A 0

B 1

C π

D $-\infty$

E does not exist

Exercise

$$\lim_{x \rightarrow 0} \arctan \frac{1}{x^2}$$

A 0

B 1

C $\frac{\pi}{2}$

D $-\frac{\pi}{4}$

E ∞

Theorem 7 (Heine)

Let $c \in \mathbb{R}^*$, $A \in \mathbb{R}^*$ and the function f satisfies $\lim_{x \rightarrow c} f(x) = A$.
If the sequence $\{x_n\}$ satisfies $x_n \in D_f$, $x_n \neq c$ for all $n \in \mathbb{N}$ and $\lim_{n \rightarrow \infty} x_n = c$, then $\lim_{n \rightarrow \infty} f(x_n) = A$.

Example

$$\lim_{n \rightarrow \infty} \ln \left(\frac{n + \sin n}{n - \cos n} \right)$$

$$\lim_{n \rightarrow \infty} \cos \left(\sin \left(\frac{\pi}{2} \frac{1}{n^2} \right) \right)$$

Theorem 8 (limit of a monotone function)

Let $a, b \in \mathbb{R}^*$, $a < b$. Suppose that f is a function monotone on an interval (a, b) . Then the limits $\lim_{x \rightarrow a^+} f(x)$ and $\lim_{x \rightarrow b^-} f(x)$ exist. Moreover,

- if f is non-decreasing on (a, b) , then
 $\lim_{x \rightarrow a^+} f(x) = \inf f((a, b))$ and
 $\lim_{x \rightarrow b^-} f(x) = \sup f((a, b))$;
- if f is non-increasing on (a, b) , then
 $\lim_{x \rightarrow a^+} f(x) = \sup f((a, b))$ and
 $\lim_{x \rightarrow b^-} f(x) = \inf f((a, b))$.



Figure: <https://www.geogebra.org/calculator/bfutkyne>

Definition

Let $J \subset \mathbb{R}$ be a non-degenerate interval (i.e. it contains infinitely many points). A function $f: J \rightarrow \mathbb{R}$ is **continuous on the interval J** if

- f is continuous at every inner point J ,
- f is continuous from the right at the left endpoint of J if this point belongs to J ,
- f is continuous from the left at the right endpoint of J if this point belongs to J .

Theorem 9 (continuity of the compound function on an interval)

Let I and J be intervals, $g: I \rightarrow J$, $f: J \rightarrow \mathbb{R}$, let g be continuous on I and let f be continuous on J . Then the function $f \circ g$ is continuous on I .

Theorem 10 (Bolzano, intermediate value theorem)

Let f be a function continuous on an interval $[a, b]$ and suppose that $f(a) < f(b)$. Then for each $C \in (f(a), f(b))$ there exists $\xi \in (a, b)$ satisfying $f(\xi) = C$.

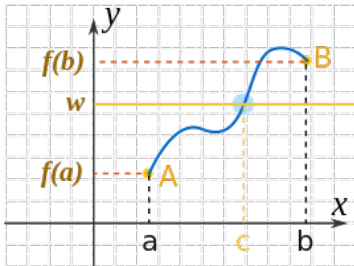

Theorem 10 (Bolzano, intermediate value theorem)

Let f be a function continuous on an interval $[a, b]$ and suppose that $f(a) < f(b)$. Then for each $C \in (f(a), f(b))$ there exists $\xi \in (a, b)$ satisfying $f(\xi) = C$.

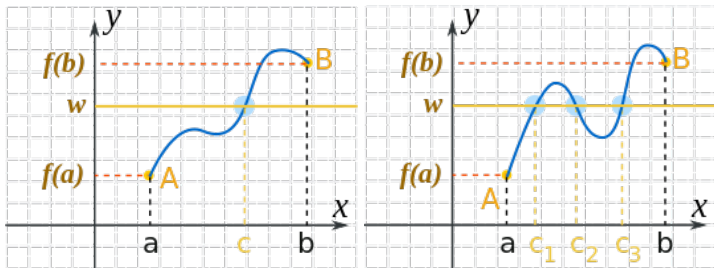

Figure: <https://www.mathsisfun.com/algebra/intermediate-value-theorem.html>

Theorem 11 (Bolzano, intermediate value theorem)

Let f be a function continuous on an interval $[a, b]$ and suppose that $f(a) < f(b)$. Then for each $C \in (f(a), f(b))$ there exists $\xi \in (a, b)$ satisfying $f(\xi) = C$.

Exercise

Is there a solution between 0 and 2?

- $x^5 - 2x - 1 = 0$
- $x^3 - 4x^2 + 4x + 1 = 0$
- $5x^3 - 15x^2 + 10x + 1 = 0$

https:

[//www.geogebra.org/calculator/pqbtmk54](https://www.geogebra.org/calculator/pqbtmk54)

Theorem 12 (an image of an interval under a continuous function)

Let J be an interval and let $f: J \rightarrow \mathbb{R}$ be a function continuous on J . Then $f(J)$ is an interval.

Exercise

Find the image of the interval $(-1, 2]$ under the functions

- x^2
- $\operatorname{sgn} x$

Definition

Let $M \subset \mathbb{R}$, $x \in M$ and a function f is defined at least on M (i.e. $M \subset D_f$). We say that f attains its **maximum** (resp. **minimum**) **on M** at $x \in M$ if

$$\forall y \in M: f(y) \leq f(x) \quad (\text{resp. } \forall y \in M: f(y) \geq f(x)).$$

The point x is called the **point of maximum** (resp. **minimum**) of the function f on M . The symbol $\max_M f$ (resp. $\min_M f$) denotes the maximal (resp. minimal) value of f on M (if such a value exists). The points of maxima or minima are collectively called the points of **extrema**.

Definition

Let $M \subset \mathbb{R}$, $x \in M$ and a function f is defined at least on M (i.e. $M \subset D_f$). We say that the function f has at x

- a **local maximum with respect to M** if there exists $\delta > 0$ such that $\forall y \in B(x, \delta) \cap M: f(y) \leq f(x)$,
- a **local minimum with respect to M** if there exists $\delta > 0$ such that $\forall y \in B(x, \delta) \cap M: f(y) \geq f(x)$,
- a **strict local maximum with respect to M** if there exists $\delta > 0$ such that $\forall y \in P(x, \delta) \cap M: f(y) < f(x)$,
- a **strict local minimum with respect to M** if there exists $\delta > 0$ such that $\forall y \in P(x, \delta) \cap M: f(y) > f(x)$.

The points of local maxima or minima are collectively called the points of **local extrema**.

Exercise

Find local extrema:

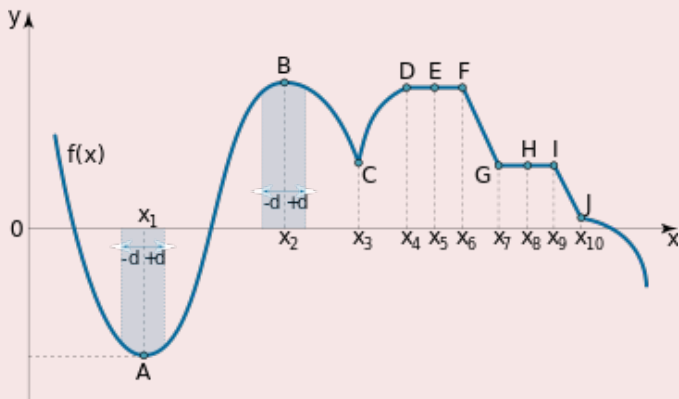

Figure: <https://math24.net/local-extrema-functions.html>

Theorem 13 (extrema of continuous functions)

Let f be a function continuous on an interval $[a, b]$. Then f attains its maximum and minimum on $[a, b]$.

Theorem 13 (extrema of continuous functions)

Let f be a function continuous on an interval $[a, b]$. Then f attains its maximum and minimum on $[a, b]$.

Corollary 14 (boundedness of a continuous function)

Let f be a function continuous on an interval $[a, b]$. Then f is bounded on $[a, b]$.

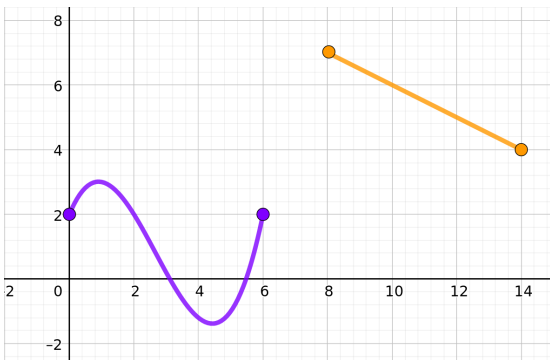

Theorem 15 (continuity of an inverse function)

Let f be a continuous function that is increasing (resp. decreasing) on an interval J . Then the function f^{-1} is continuous and increasing (resp. decreasing) on the interval $f(J)$.

Corollary 16

Functions n th root, exponential, general power, arcsin, arccos, arctg, arccotg are continuous on their domains.

